

PORTABLE AIR CONDITIONER(Local Air Conditioner)

---

# Owner's Manual & Installation Manual



**IMPORTANT NOTE:**

Read this manual carefully before installing or operating your new air conditioning unit. Make sure to save this manual for future reference.

# Table of Contents

## Safety Precautions

Safety Precautions . . . . . 03

## Installation Instructions

Preparation.....06  
Design Notice.....06  
Ambient Temperature Range For Unit Operating.....06  
Exhaust Hose Installation.....06  
Choosing The Right Location.....07  
Energy Rating Information .....07  
Tools Needed.....08  
Accessories.....08  
Window Installation Kit.....09  
Installation.....10

## Operating Instructions

Control Panel Features.....12  
Operation Instructions.....13  
Other features.....14

## Maintenance

Safety Precautions.....15  
Air Filter Cleaning .....16  
Unit Cleaning .....16  
Store the unit when not in use .....16

## Troubleshooting Tips

Troubleshooting Tips .....17

# Safety Precautions

## Read Safety Precautions Before Operation and Installation

To prevent death or injury to the user or other people and property damage, the following instructions must be followed. Incorrect operation due to ignoring of instructions may cause death, harm or damage.



### **WARNING**

This symbol indicates the possibility of personnel injury or loss of life.



### **CAUTION**

This symbol indicates the possibility of property damage or serious consequences.



### **WARNING**

- Installation must be performed according to the installation instructions. Improper installation can cause water leakage, electrical shock, or fire.
- Use only the included accessories and parts, and specified tools for the installation. Using non-standard parts can cause water leakage, electrical shock, fire, and injury or property damage.
- Make sure that the outlet you are using is grounded and has the appropriate voltage. The power cord is equipped with a three-prong grounding plug to protect against shock. Voltage information can be found on the nameplate of the unit.
- Your unit must be used in a properly grounded wall receptacle. If the wall receptacle you intend to use is not adequately grounded or protected by a time delay fuse or circuit breaker (the fuse or circuit breaker needed is determined by the maximum current of the unit. The maximum current is indicated on the nameplate located on unit), have a qualified electrician install the proper receptacle.
- Install the unit on a flat, sturdy surface. Failure to do so could result in damage or excessive noise and vibration.
- The unit must be kept free from obstruction to ensure proper function and to mitigate safety hazards.
- Do not modify the length of the power cord or use an extension cord to power the unit.
- Do not share a single outlet with other electrical appliances. Improper power supply can cause fire or electrical shock.
- Do not install your air conditioner in a wet room such as a bathroom or laundry room. Too much exposure to water can cause electrical components to short circuit.
- Do not install the unit in a location that may be exposed to combustible gas, as this could cause fire.  
The unit has wheels to facilitate moving. Make sure not to use the wheels on thick carpet or to roll over objects, as these could cause tipping.
- Do not operate a unit that it has been dropped or damaged.
- The appliance with electric heater shall have at least 1 meter space to the combustible materials.
- Do not touch the unit with wet or damp hands or when barefoot.
- If the air conditioner is knocked over during use, turn off the unit and unplug it from the main power supply immediately. Visually inspect the unit to ensure there is no damage. If you suspect the unit has been damaged, contact a technician or customer service for assistance.

- In a thunderstorm, the power must be cut off to avoid damage to the machine due to lightning.
- Your air conditioner should be used in such a way that it is protected from moisture. e.g. condensation, splashed water, etc. Do not place or store your air conditioner where it can fall or be pulled into water or any other liquid. Unplug immediately if it occurs.
- All wiring must be performed strictly in accordance with the wiring diagram located inside of the unit.
- The unit's circuit board(PCB) is designed with a fuse to provide overcurrent protection. The specifications of the fuse are printed on the circuit board, such as: T 3.15A/250V, etc.
- When the water drainage function is not in use, keep the upper and the lower drain plug firmly to the unit to get rid of choking. When the drain plug is not in use, keep it carefully to prevent children from choking.

**CAUTION**

- This appliance can be used by children aged from 8 years and above and person with reduced physical, sensory or mental capabilities or lack of experience and knowledge if they have been given supervision or instruction concerning use of the appliance in a safe way and understand the hazards involved. Children shall not play with the appliance. Cleaning and user maintenance shall not be made by children without supervision. (be applicable for the European Countries)
- This appliance is not intended for use by persons (including children) with reduced physical, sensory or mental capabilities or lack of experience and knowledge, unless they have been given supervision or instruction concerning use of the appliance by a person responsible for their safety. Children should be supervised to ensure that they do not play with the appliance. Children must be supervised around the unit at all times.(be applicable for other countries except the European Countries )
- If the supply cord is damaged, it must be replaced by the manufacturer, its service agent or similarly qualified persons in order to avoid a hazard.
- Prior to cleaning or other maintenance, the appliance must be disconnected from the supply mains.
- Do not remove any fixed covers. Never use this appliance if it is not working properly, or if it has been dropped or damaged.
- Do not run cord under carpeting. Do not cover cord with throw rugs, runners, or similar coverings. Do not route cord under furniture or appliances. Arrange cord away from traffic area and where it will not be tripped over.
- Do not operate unit with a damaged cord, plug, power fuse or circuit breaker. Discard unit or return to an authorized service facility for examination and/or repair.
- To reduce the risk of fire or electric shock, do not use this fan with any solid-state speed control device.
- The appliance shall be installed in accordance with national wiring regulations.
- Contact the authorised service technician for repair or maintenance of this unit.
- Contact the authorised installer for installation of this unit.
- Do not cover or obstruct the inlet or outlet grilles.
- Do not use this product for functions other than those described in this instruction manual.
- Before cleaning, turn off the power and unplug the unit.

- Disconnect the power if strange sounds, smell, or smoke comes from it.
- Do not press the buttons on the control panel with anything other than your fingers.
- Do not remove any fixed covers. Never use this appliance if it is not working properly, or if it has been dropped or damaged.
- Do not operate or stop the unit by inserting or pulling out the power cord plug.
- Do not use hazardous chemicals to clean or come into contact with the unit. Do not use the unit in the presence of inflammable substances or vapour such as alcohol, insecticides, petrol, etc.
- Always transport your air conditioner in a vertical position and stand on a stable, level surface during use.
- Always contact a qualified person to carry out repairs. If the damaged power supply cord must be replaced with a new power supply cord obtained from the product manufacturer and not repaired.
- Hold the plug by the head of the power plug when taking it out.
- Turn off the product when not in use.

### Note about Fluorinated Gasses (Not applicable to the unit using R290 Refrigerant)

1. Fluorinated greenhouse gases are contained in hermetically sealed equipment. For specific information on the type, the amount and the CO<sub>2</sub> equivalent in tonnes of the fluorinated greenhouse gas (on some models), please refer to the relevant label on the unit itself.
2. Installation, service, maintenance and repair of this unit must be performed by a certified technician.
3. Product uninstallation and recycling must be performed by a certified technician.

## Sociable Remark

When using this dehumidifier in the European countries, the following information must be followed:

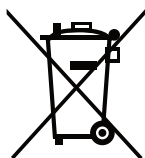

**DISPOSAL:** Do not dispose this product as unsorted municipal waste. Collection of such waste separately for special treatment is necessary.

It is prohibited to dispose of this appliance in domestic household waste.

For disposal, there are several possibilities:

- The municipality has established collection systems, where electronic waste can be disposed of at least free of charge to the user.
- When buying a new product, the retailer will take back the old product at least free of charge.
- The manufacture will take back the old appliance for disposal at least free of charge to the user.
- As old products contain valuable resources, they can be sold to scrap metal dealers. Wild disposal of waste in forests and landscapes endangers your health when hazardous substances leak into the ground-water and find their way into the food chain.

# Installation Instructions

## Preparation

The unit can be controlled by the unit control panel alone or with the remote controller. This manual does not include Remote Controller Operations, see the <<Remote Controller Instruction>> packed with the unit for details.

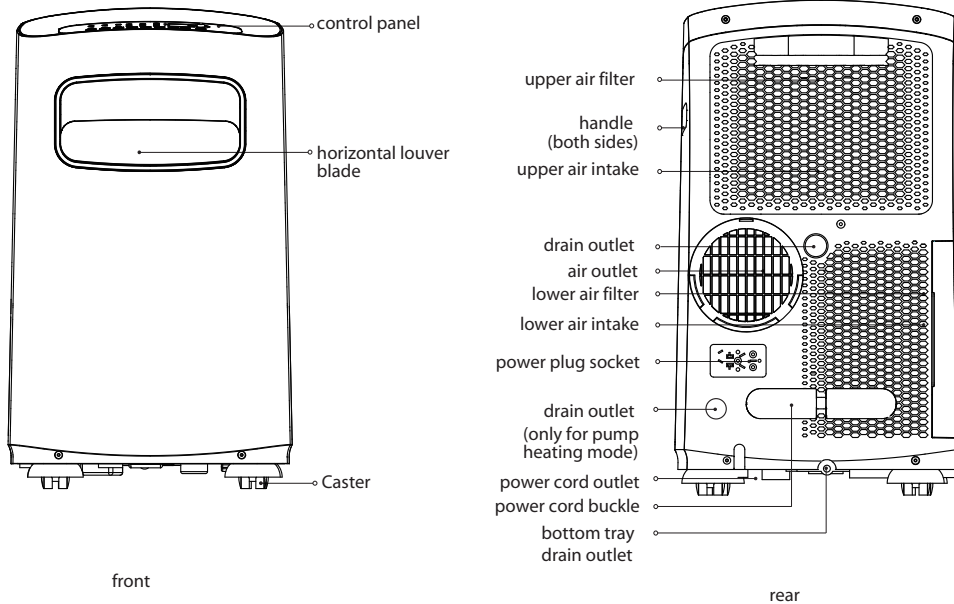

## Design Notice

In order to ensure the optimal performance of our products, the design specifications of the unit and remote control are subject to change without prior notice.

## Ambient Temperature Range For Unit Operating

MODE	Temperature Range	MODE	Temperature Range
Cool	17-35°C (62-95°F)	Heat(pump heat mode)	5-30°C (41-86°F)
Dry	13-35°C (55-95°F)	Heat(electrical heat mode)	≤ 30°C (86°F)

## Exhaust hose installation

The exhaust hose and adaptor must be installed or removed in accordance with the usage mode. For COOL, HEAT (heat pump type) or AUTO mode must be installed exhaust hose. For FAN, DRY or HEAT (electrical heat type) mode must be removed exhaust hose.

## Choosing The Right Location

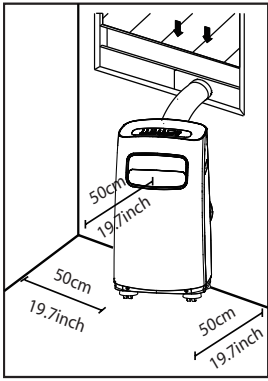

Your installation location should meet the following requirements:

- Make sure that you install your unit on an even surface to minimize noise and vibration.
- The unit must be installed near a grounded plug, and the Collection Tray Drain (found on the back of the unit) must be accessible.
- The unit should be located at least 30cm (12") from the nearest wall to ensure proper air conditioning. The horizontal louver blade should be at least 50cm (19.7") away from obstacles.
- DO NOT cover the Intakes, Outlets or Remote Signal Receptor of the unit, as this could cause damage to the unit.

## Recommend Installation

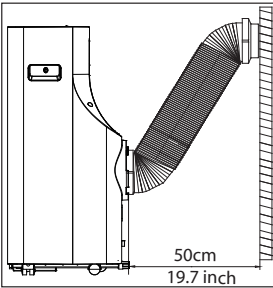

## Energy Rating Information

The energy rating and noise information for this unit is based on the standard installation using an un-extended exhaust duct (Diameter:150mm, Length:1.5m) without window slider adaptor or wall exhaust adaptor A.

The unit with 3 meters extended exhaust duct is running by using 2 exhaust ducts(Diameter:150mm, Length:1.5m + Diameter: 130mm, Length: 1.5m) . The Energy rating and noise information for unit with 3 meters extended exhaust duct is not assessed.(For some models)

NOTE:

We recommend that operating the unit at room temperature below 35°C . Since there is a risk that the unit with 3 meters extended exhaust duct would not work at room temperature above 35°C under some extreme conditions, such as the lower air intake be blocked for 50%.

## How to Stay Cool with a New Portable Air Conditioner(For the models comply with the requirements of Department Of Energy in US)

Because of a new federal test procedure for Portable Air Conditioners, you may notice that the cooling capacity claims on portable air conditioner packaging are significantly lower than that of models produced prior to 2017. This is due to changes in the test procedure, not to the portable air conditioners themselves.

### What should I look for first when purchasing a portable air conditioner?

The right air conditioner helps you cool a room efficiently. An undersized unit won't cool adequately while one that's too large will not remove enough humidity, leaving the air feeling damp. To find the proper air conditioner, determine the square footage of the room you want to cool by multiplying the room length by its width. You also need to know the air conditioner's BTU (British Thermal Unit) rating, which indicates the amount of heat it can remove from a room. A higher

number means more cooling power for a larger room. (Be sure you are comparing only newer models to each other- older models may appear to have a higher capacity, but are actually the same). Be sure to “size up” if your portable air conditioner will be placed in a very sunny room, in a kitchen, or in a room with high ceilings. After you’ve found the right cooling capacity or your room, you can look at other features.

Why is the cooling capacity lower on newer models than on older units?

Federal regulations require manufacturers to calculate cooling capacity based on a specific test procedure, which was changed just this year. Models manufactured before 2017 were tested under a different procedure and cooling capacity is measured differently than in prior years’ models. So, while the BTUs may be lower, the actual cooling capacity of the air conditioners has not changed.

What is SACC ?













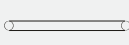

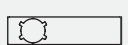
SACC is the representative value of Seasonally Adjusted Cooling Capacity, in Btu/h, as determined in accordance with the DOE test procedure at title 10 Code of Federal Regulations (CFR) 430, subpart B, appendix CC and applicable sampling plans.

**Tools Needed**

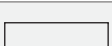
- Medium Philips screwdriver; -Tape measure or ruler; -Knife or scissors;
- Saw (On some models, to shorten window adaptor for narrow windows)













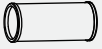



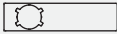

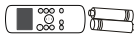
**Accessories**

North America

Shape	Name of Accessories	Qty.	Shape	Name of Accessories	Qty.
	Unit Adaptor	1 pc		Security Bracket and 2 Screws	1 set
	Exhaust Hose	1 pc		Drain Hose	1 pc
	Window Slider Adaptor	1 pc		Power Cord Buckle	1 pc
	Window Slider A	1 pc		Bolt	1 pc/2 pc(*)
	Window Slider B	1 pc		Remote Controller and Battery (only for remote control models)	1 set(*)
	Window Slider C	1 pc(*)		Drain Hose Adaptor (only for heat pump mode)	1 pc(*)
	Foam Seal A (Adhesive)	2 pc/4 pc(*)		Exhaust Hose Adaptor	1 pc(*)
	Foam Seal B (Adhesive)	2 pc		Extended Exhaust Hose	1 pc(*)
	Foam Seal C (Non-adhesive)	1 pc/2 pc(*)			

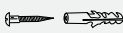

## Other Regions

Shape	Name of Accessories	Qty.	Shape	Name of Accessories	Qty.
	Unit Adaptor	1 pc		Security Bracket and 2 Screws	1 set(*)
	Exhaust Hose	1 pc		Drain Hose	1 pc
	Window Slider Adaptor	1 pc(*)		Power Cord Buckle	1 pc
	Window Slider A	1 pc(*)		Bolt	1 pc(*)
	Window Slider B	1 pc(*)		Remote Controller and Battery (only for remote control models)	1 set(*)
	Foam Seal A (Adhesive)	2 pc(*)		Wall Exhaust Adaptor A (only for wall installation models)	1 pc(*)
	Foam Seal B (Adhesive)	2 pc(*)		Wall Exhaust Adaptor B (with cap) (only for wall installation models)	1 pc(*)
	Foam Seal C (Non-adhesive)	1 pc(*)		Screw and anchor (only for wall installation models)	4 set(*)
	Drain Hose Adaptor (only for heat pump mode)	1 pc(*)		Extended Exhaust Hose	1 pc(*)
	Exhaust Hose Adaptor	1 pc(*)			

## Window Installation Kit

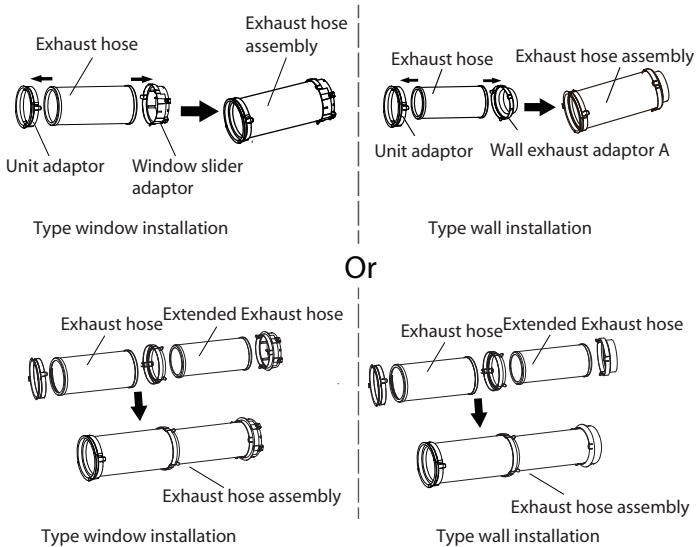

### Step One: Preparing the Exhaust Hose assembly

Press the exhaust hose (or extended exhaust hose) into the window slider adaptor (or wall exhaust adaptor) and unit adaptor, clamp automatically by elastic buckles of the adaptors.

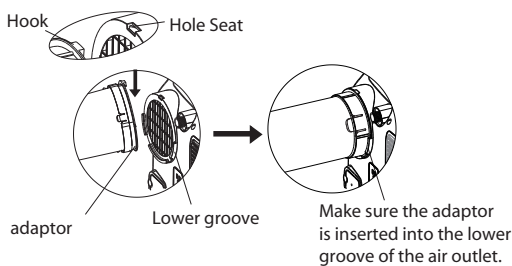

### Step Two: Install the Exhaust hose assembly to the unit

Insert unit adaptor of the Exhaust hose assembly into the lower groove of the air outlet of the unit while the hook of the adaptor is aligned with the hole seat of the air outlet and slide down the Exhaust hose assembly along the arrow direction for installation.

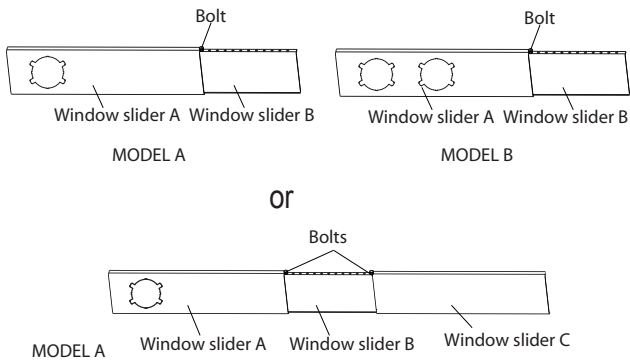

### Step Three: Preparing the Adjustable Window Slider

1. Depending on the size of your window, adjust the size of the window slider.
2. If the length of the window requires two or three window sliders, use the bolt(s) to fasten the window sliders once they are adjusted to the proper length.

## Installation

**NOTE:** Once the Exhaust Hose assembly and Adjustable Window Slider are prepared, choose from one of the following two installation methods.

### Type 1: Hung Window or Sliding Window Installation(For some models)

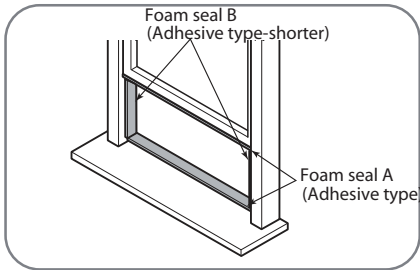

Or

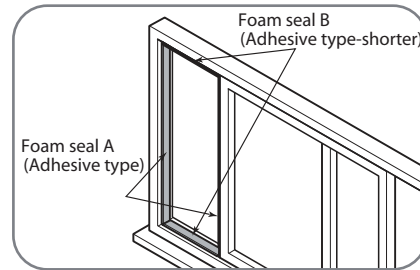

1. Cut the adhesive foam seal A and B strips to the proper lengths, and attach them to the window sash and frame as shown.

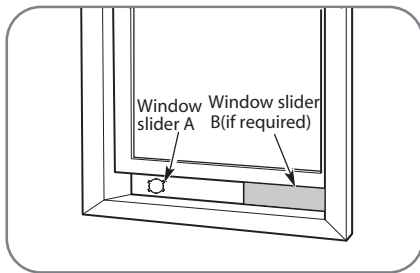

Or

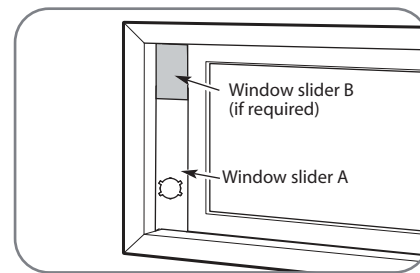

2. Insert the window slider assembly into the window opening.

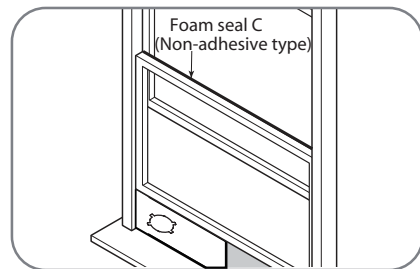

Or

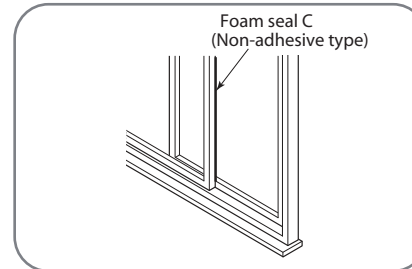

3. Cut the non-adhesive foam seal C strip to match the width(or height) of the window. Insert the seal between the glass and the window frame to prevent air and insects from getting into the room.

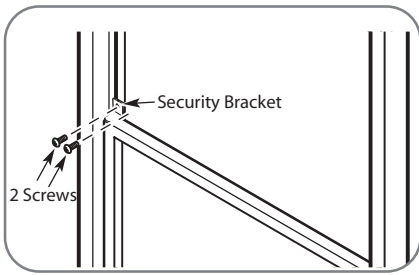

Or

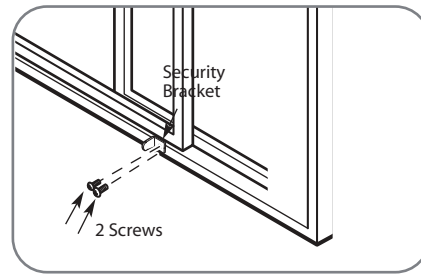

4. If desired, install the security bracket with 2 screws as shown.

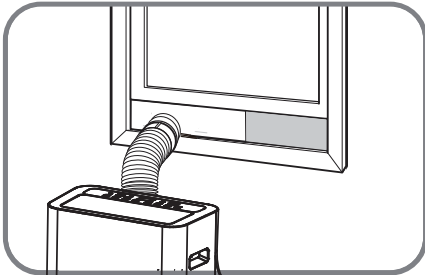

Or

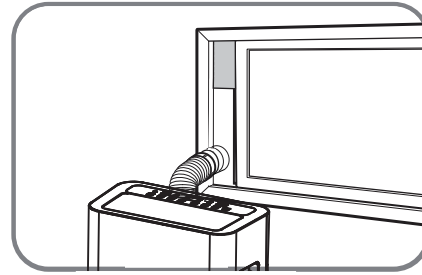

5. Insert the window slider adaptor into the hole of the window slider.

### Type 2: Wall Installation(For some models)

1. Cut a 125mm (4.9inch) hole into the wall for the Wall Exhaust Adaptor B.
2. Secure the Wall Exhaust Adaptor B to the wall using the four Anchors and Screws provided in the kit.
3. Connect the Exhaust Hose Assembly(with Wall Exhaust Adaptor A) to the Wall Exhaust Adaptor B.

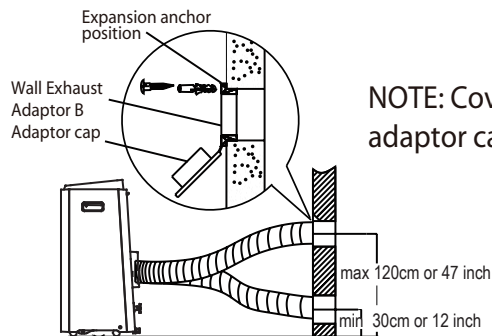

NOTE: To ensure proper function, DO NOT overextend or bend the hose. Make sure that there is no obstacle around the air outlet of the exhaust hose (in the range of 500mm) in order to the exhaust system works properly. All the illustrations in this manual are for explanation purpose only. Your air conditioner may be slightly different. The actual shape shall prevail.



# Operating Instructions

## Control Panel Features

NOTE: The following control panels are for explanation purpose only. The control panel of the unit you purchased may be slightly different according to the models. Your machine may not contain some indicators or buttons. The actual shape shall prevail.

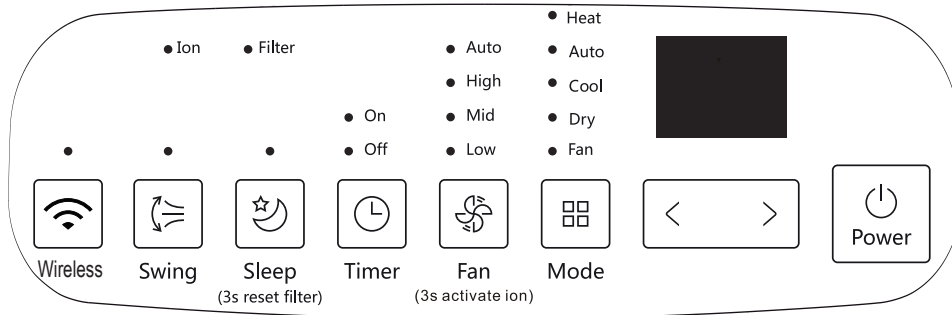

### Wireless button(On some models)

Used to initiate the wireless connection mode. For the first time to use wireless function, press the wireless button for 3 seconds to initiate the wireless connection mode. The LED DISPLAY shows 'AP' to indicate you can set wireless connection. If connection(router) is successful within 8 minutes, the unit will exit wireless connection mode automatically and the wireless indicator illuminates. If connection is failure within 8 minutes, the unit exits wireless connection mode automatically. After Wireless connection is successful, for some models you can press Wireless and DOWN (-) buttons at the same time for 0.5 seconds to turn off Wireless function and the LED DISPLAY shows 'OF' for 3 seconds, press Wireless button to turn on Wireless function and the LED DISPLAY shows 'ON' for 3 seconds.

NOTE: When you restart the wireless function, it may take a period of time to connect to the network automatically.

### Swing button(On some models)

(Applicable to the models with auto swing feature only)

Used to initiate the Auto swing feature. When the operation is ON, press the SWING button can stop the louver at the desired angle.

### Sleep(Eco)/Filter button

Used to initiate the SLEEP/ECO operation.

NOTE: After 250 hours of operation, the filter indicator light illuminates. This feature is a reminder to clean the Air Filter for more efficient operation. Press this button for 3 seconds to cancel the reminder.

### Timer button

Used to initiate the AUTO ON start time and AUTO OFF stop time program, in conjunction with the + & - buttons. The timer on/off indicator light illuminates under the timer on/off settings.

### Fan/Ion(On some models) button

Control the fan speed. Press to select the fan speed in four steps-LOW, MID(MED), HIGH and AUTO. The fan speed indicator light illuminates under different fan settings.

NOTE: Press this button for 3 seconds to initiate ION feature. The ion generator is energized and will help to remove pollen and impurities from the air, and trap them in the filter. Press it for 3 seconds again to stop the ION feature.

### Mode button

Selects the appropriate operating mode. Each time you press the button, a mode is selected in a sequence that goes from AUTO, COOL, DRY, FAN and HEAT (cooling only models without).The mode indicator light illuminates under the different mode settings.



Up (+) and Down (-) buttons  
Used to adjust (increasing/decreasing) temperature settings in 1°C/1°F (or 2°F) increments in a range of 17°C/62°F to 30°C/86°F (or 88°F) or the TIMER setting in a range of 0~24hrs.

NOTE: The control is capable of displaying temperature in degrees Fahrenheit or degrees Celsius. To convert from one to the other, press and hold the Up and Down buttons at the same time for 3 seconds.



Power button  
Power switch on/off.



LED display  
Shows the set temperature in °C or °F and the Auto-timer settings. While on DRY and FAN modes, it shows the room temperature.  
Shows Error codes and protection code:

- E1-Room temperature sensor error.
- E2-Evaporator temperature sensor error.
- E3-Condenser temperature sensor error (on some models).
- E4-Display panel communication error.
- EC-Refrigerant leakage detection malfunction(on some models).
- E7-Zero-crossing malfunction.
- P1-Bottom tray is full--Connect the drain hose and drain the collected water away.If protection repeats, call for service.

Note: When one of the above malfunctions occurs, turn off the unit, and check for any obstructions. Restart the unit, if the malfunction is still present, turn off the unit and unplug the power cord. Contact the manufacturer or its service agents or a similar qualified person for service.

## Operation Instructions

### COOL operation

- Press the "MODE" button until the "COOL" indicator light comes on.
- Press the ADJUST buttons "+" or "-" to select your desired room temperature. The temperature can be set within a range of 17°C~30°C/62°F~88°F(or 86°F).
- Press the "FAN SPEED" button to choose the fanspeed.

### HEAT operation(cooling only models without)

- Press the "MODE" button until the "HEAT" indicator light comes on.
- Press the ADJUST buttons "+" or "-" to select your desired room temperature. The temperature can be set within a range of 17°C~30°C/62°F~88°F (or 86°F).
- Press the "FAN SPEED" button to choose the fan speed.

Note: For some models, the fan speed can not be adjusted under HEAT mode.

### DRY operation

- Press the "MODE" button until the "DRY" indicator light comes on.
- Under this mode, you cannot select a fan speed or adjust the temperature. The fan motor operates at LOW speed.
- Keep windows and doors closed for the best dehumidifying effect.
- Do not put the duct to window.

### AUTO operation

- When you set the air conditioner in AUTO mode, it will automatically select cooling, heating(cooling only models without), or fan only operation depending on what temperature you have selected and the room temperature.
- The air conditioner will control room temperature automatically round the temperature point set by you.
- Under AUTO mode, you can not select the fan speed.

NOTE: Under AUTO mode, both the AUTO mode and the actual operation mode indicator lights illuminate for some models.

### FAN operation

- Press the "MODE" button until the "FAN " indicator light comes on.
- Press the "FAN SPEED" button to choose the fan speed. The temperature can not be adjusted.
- Do not put the duct to window.

### TIMER operation

- When the unit is on, press the Timer button will initiate the Auto-off stop program, the TIMER OFF indicator light illuminates. Press the UP or down button to select the desired time. Press the TIMER button again within 5 seconds, the Auto-on start program is initiated. And the TIMER ON indicator

- light illuminates. Press the up or down button to select the desired Auto-on start time.
- When the unit is off, press the Timer button to initiate the Auto-on start program, press it again within five seconds will initiate the Auto-off stop program.
  - Press or hold the UP or DOWN button to change the Auto time by 0.5 hour increments, up to 10 hours, then at 1 hour increments up to 24 hours. The control will count down the time remaining until start.
  - The system will automatically revert back to display the previous temperature setting if there is no operation in a 5 seconds period.
  - Turning the unit ON or OFF at any time or adjusting the timer setting to 0.0 will cancel the Auto Start/Stop timer program.
  - When the malfunction occurs, the Auto Start/Stop timed program will also be cancelled.

#### SLEEP/ECO operation

- Press this button, the selected temperature will increase(cooling) or decrease(heating) by 1°C/2°F(or 1°F) 30 minutes.The temperature will then increase (cooling) or decrease (heating) by another 1°C/2°F(or 1°F) after an additional 30 minutes. This new temperature will be maintained for 7 hours before it returns to the originally selected temperature. This ends the Sleep/Eco mode and the unit will continue to operate as originally programmed.

NOTE: This feature is unavailable under FAN or DRY mode.

### Other features

#### FOLLOW ME/TEMP SENSING feature(On some models)

NOTE:This feature can be activated from the remote control ONLY. The remote control serves as a remote thermostat allowing for the precise temperature control at its location.

To activate the Follow Me/Temp Sensing feature, point the remote control towards the unit and press the Follow Me/Temp Sensing button. The remote control will send this signal to the air conditioner until press the Follow Me/Temp Sensing button again. If the unit does not receive the Follow Me/Temp Sensing signal during any 7 minutes interval, the unit will exit the Follow Me/Temp Sensing mode.

NOTE: This feature is unavailable under FAN or DRY mode.

#### AUTO-RESTART

If the unit breaks off unexpectedly due to the power cut, it will restart with the previous function setting automatically when the power resumes.

#### WAIT 3 MINUTES BEFORE RESUMING OPERATION

After the unit has stopped, it can not be restarted operation in the first 3 minutes. This is to protect the unit. Operation will automatically start after 3 minutes.

#### AIR FLOW DIRECTION ADJUSTMENT

The louver can be adjusted automatically. Adjust the air flow direction automatically :(NOTE:On some models

the louver can be adjusted manually only)

- When the Power is ON, the louver opens fully.
- Press the SWING button on the panel or remote controller to initiate the Auto swing feature. The louver will swing up and down automatically.
- Please do not adjust the louver manually.

#### POWER MANAGEMENT feature(On some models)

Under cooling operation, when the ambient temperature is lower than the setting temperature for a period of time, the unit will be automatically operate power management feature. The compressor and fan motor stop. When the ambient temperature is higher than the setting temperature, the unit will be automatically quit the power management feature. The compressor and (or) fan motor run.

#### Water drainage

- During dehumidifying modes, remove the upper drain plug from the back of the unit, install the drain connector(5/8" universal female mender) with 3/4" hose(locally purchased). For the models without drain connector, just attach the drain hose to the hole. Place the open end of the hose directly over the drain area in your basement floor.

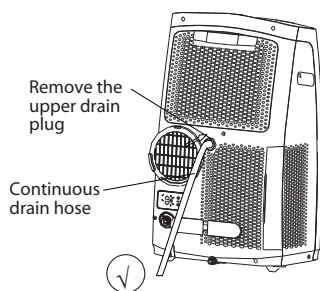

- During heating pump mode, remove the lower drain plug from the back of the unit, install the drain connector(5/8"universal female mender) with 3/4" hose(locally purchased). For the models without drain connector, just attach the drain hose to the hole. Place the open end of the Hose adaptor directly over the drain area in your basement floor.

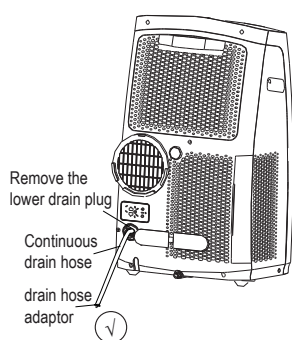

NOTE: Make sure the hose is secure so there are no leaks. Direct the hose toward the drain, making sure that there are no kinks that will stop the water flowing. Place the end of the hose into the drain and make sure the end of the hose is down to let the water flow smoothly.(See Figs with ✓). Do never let it up.(See Figs

with ✗).When the continuous drain hose is not used, ensure that the corresponding drain plug and knob are installed firmly to prevent leakage.

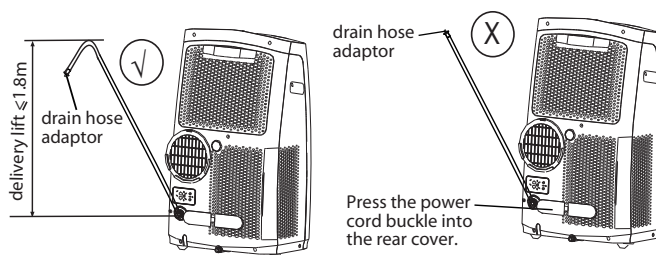

- When the water level of the bottom tray reaches a predetermined level, the unit beeps 8 times, the digital display area shows "P1". At this time the air conditioning/dehumidification process will immediately stop. However, the fan motor will continue to operate(this is normal). Carefully move the unit to a drain location, remove the bottom drain plug and let the water drain away. Reinstall the bottom drain plug and restart the machine until the "P1" symbol disappears. If the error repeats, call for service.

NOTE: Be sure to reinstall the bottom drain plug firmly to prevent leakage before using the unit.

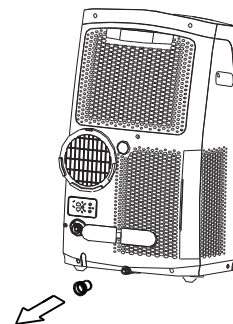

## Maintenance

### Safety Precautions

- Always unplug the unit before cleaning or servicing.
- DO NOT use flammable liquids or chemicals to clean the unit.
- DO NOT wash the unit under running water. Doing so causes electrical danger.
- DO NOT operate the machine if the power supply was damaged during cleaning. A damaged power cord must be replaced with a new cord from the manufacturer.

## Air Filter Cleaning

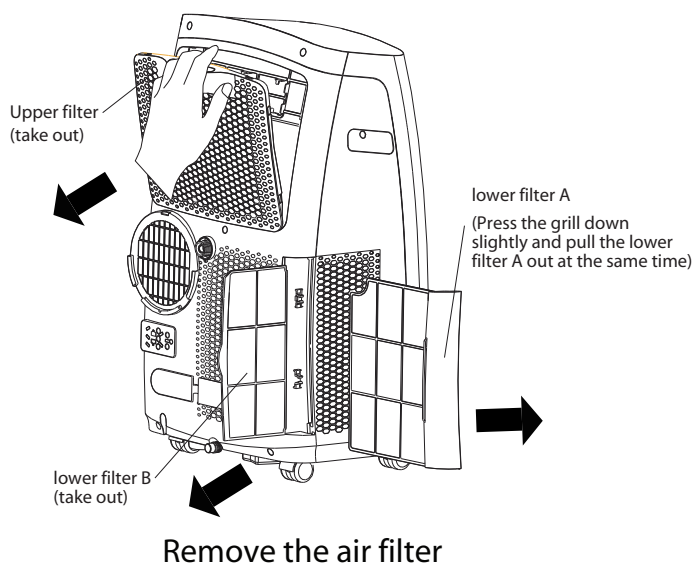

### CAUTION

DO NOT operate the unit without filter because dirt and lint will clog it and reduce performance.

### Maintenance Tips

- Be sure to clean the air filter every 2 weeks for optimal performance.
- The water collection tray should be drained immediately after P1 error occurs, and before storage to prevent mold.
- In households with animals, you will have to periodically wipe down the grill to prevent blocked airflow due to animal hair.

## Unit Cleaning

Clean the unit using a damp, lint-free cloth and mild detergent. Dry the unit with a dry, lint-free cloth.

## Store the unit when not in use

- Drain the unit's water collection tray according to the instructions in the following section.
- Run the appliance on FAN mode for 12 hours in a warm room to dry it and prevent mold.
- Turn off the appliance and unplug it.
- Clean the air filter according to the instructions in the previous section. Reinstall the clean, dry filter before storing.
- Remove the batteries from the remote control.

NOTE: Be sure to store the unit in a cool, dark place. Exposure to direct sunshine or extreme heat can shorten the lifespan of the unit.

NOTE: The cabinet and front may be dusted with an oil-free cloth or washed with a cloth dampened in a solution of warm water and mild liquid dishwashing detergent. Rinse thoroughly and wipe dry. Never use harsh cleansers, wax or polish on the cabinet front. Be sure to wring excess water from the cloth before wiping around the controls. Excess water in or around the controls may cause damage to the unit.



# Troubleshooting Tips

Problem	Possible Causes	Solution
Unit does not turn on when pressing ON/OFF button	P1 Error Code	The Water Collection Tray is full. Turn off the unit, drain the water from the Water Collection Tray and restart the unit.
	In COOL mode: room temperature is lower than the set temperature	Reset the temperature
Unit does not cool well	The air filter is blocked with dust or animal hair	Turn off the unit and clean the filter according to instructions
	Exhaust hose is not connected or is blocked	Turn off the unit, disconnect the hose, check for blockage and reconnect the hose
	The unit is low on refrigerant	Call a service technician to inspect the unit and top off refrigerant
	Temperature setting is too high	Decrease the set temperature
	The windows and doors in the room are open	Make sure all windows and doors are closed
	The room area is too large	Double-check the cooling area
The unit is noisy and vibrates too much	There are heat sources inside the room	Remove the heat sources if possible
	The ground is not level	Place the unit on a flat, level surface
The unit makes a gurgling sound	The air filter is blocked with dust or animal hair	Turn off the unit and clean the filter according to instructions
	This sound is caused by the flow of refrigerant inside the unit	This is normal





The design and specifications are subject to change without prior notice for product improvement. Consult with the sales agency or manufacturer for details. Any updates to the manual will be uploaded to the service website, please check for the latest version.